

UC501 - SOFFIT PANEL INDEX

UC501-00

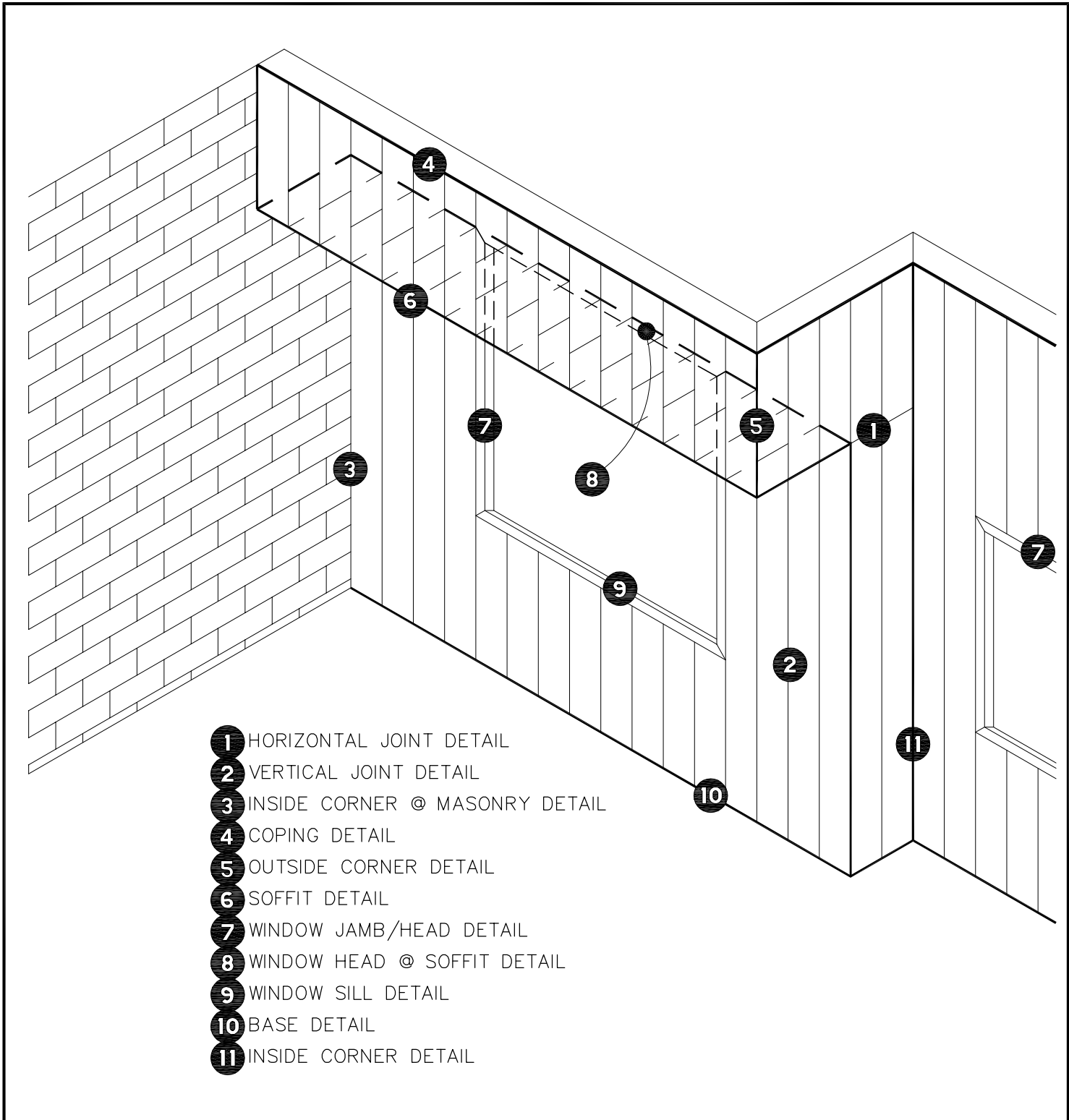

UC501 - HORIZONTAL JOINT DETAIL

UC501-01

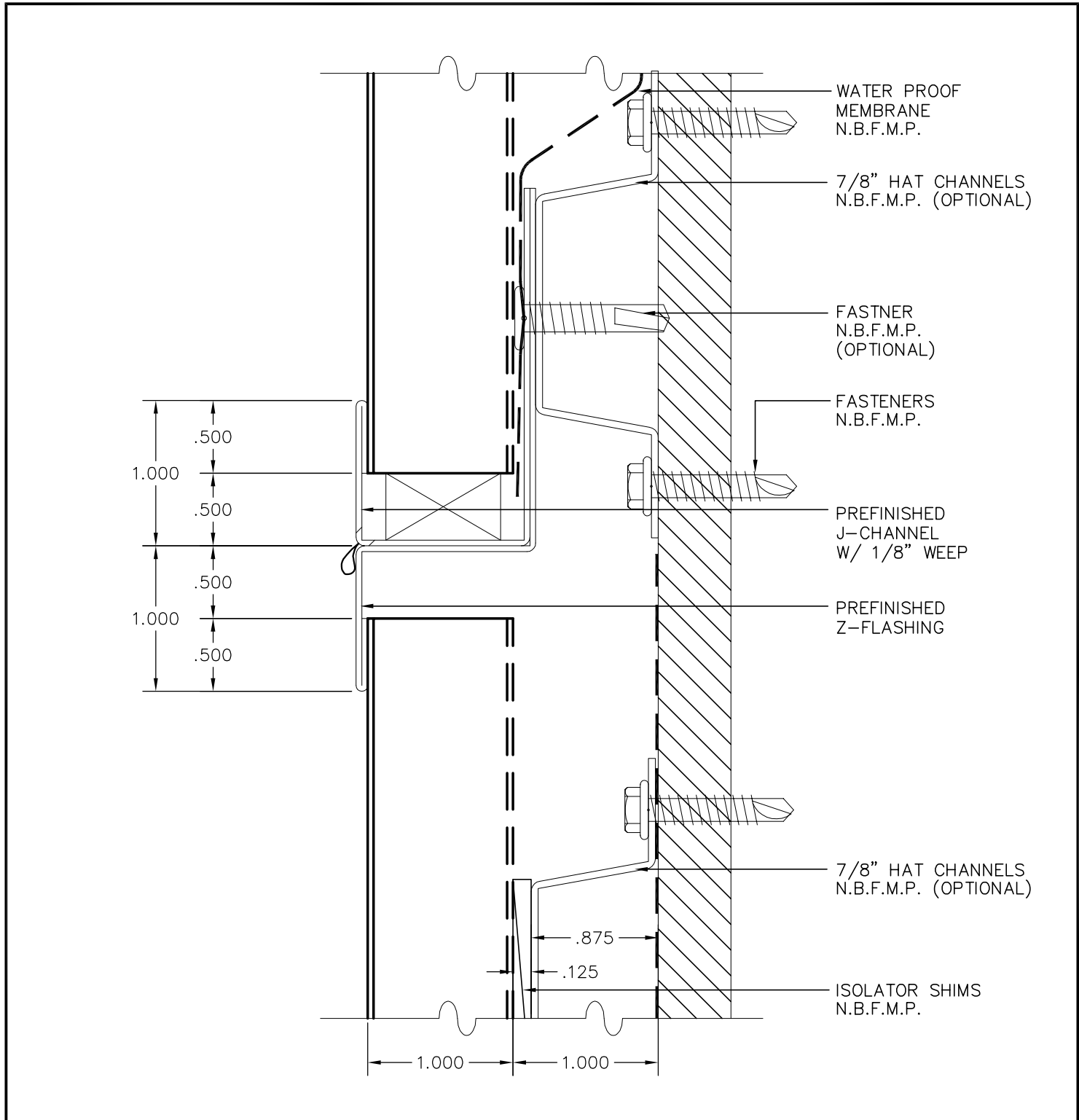

UC501 - VERTICAL JOINT DETAIL

UC501-02

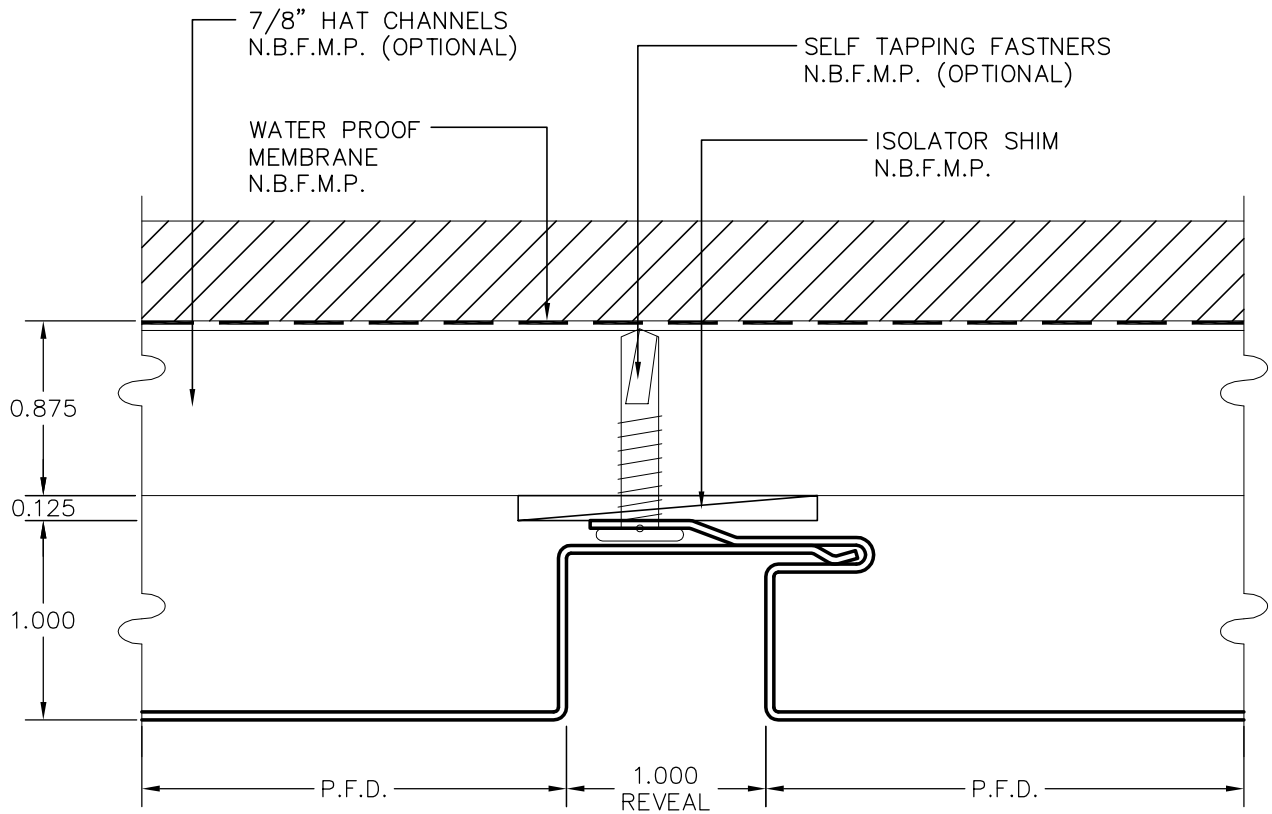

UC501 - INSIDE CORNER DETAIL @ MASONRY

UC501-03

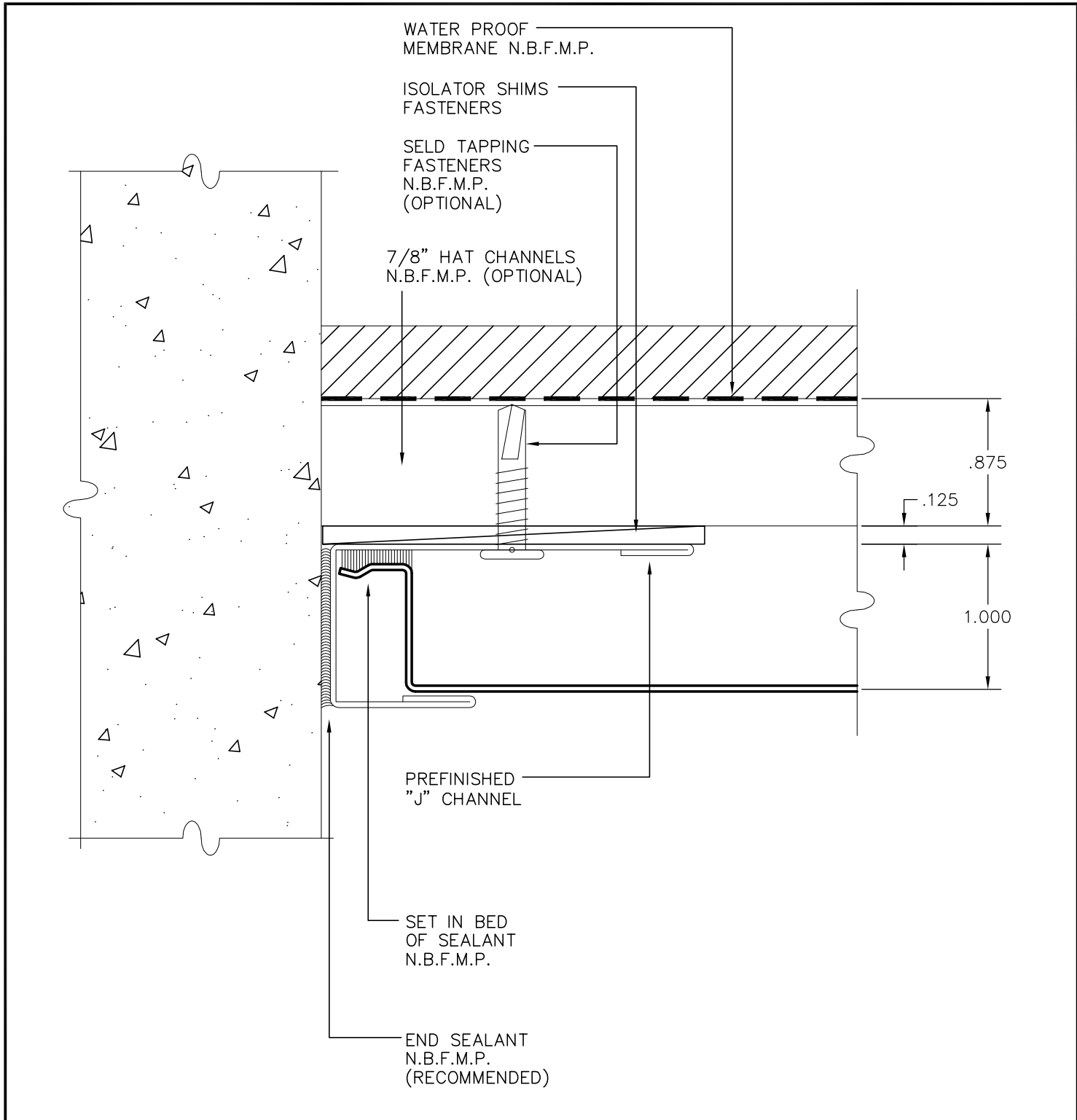

UC501 - COPING DETAIL

UC501-04

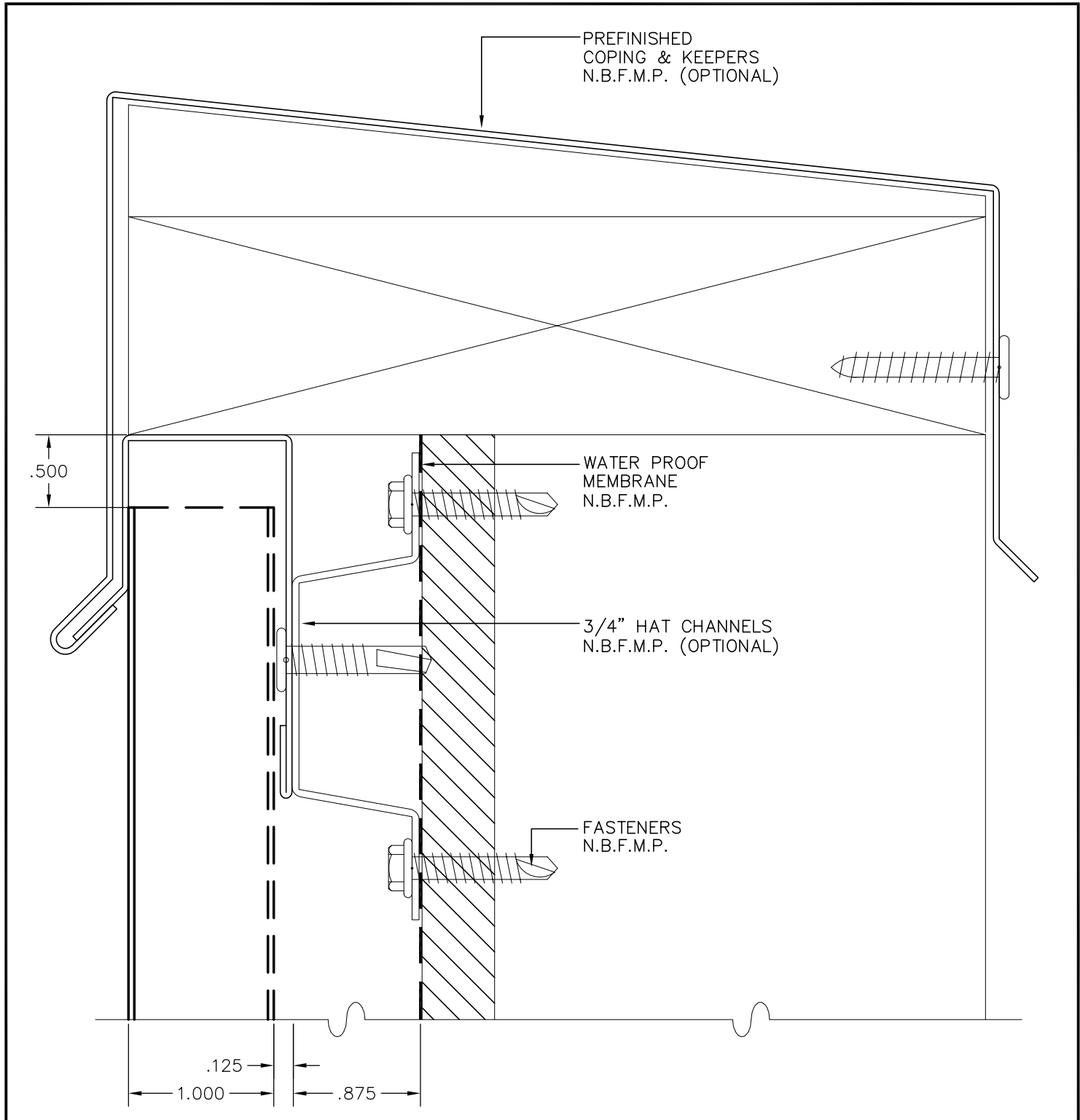

UC501 - OUTSIDE CORNER DETAIL

UC501-05

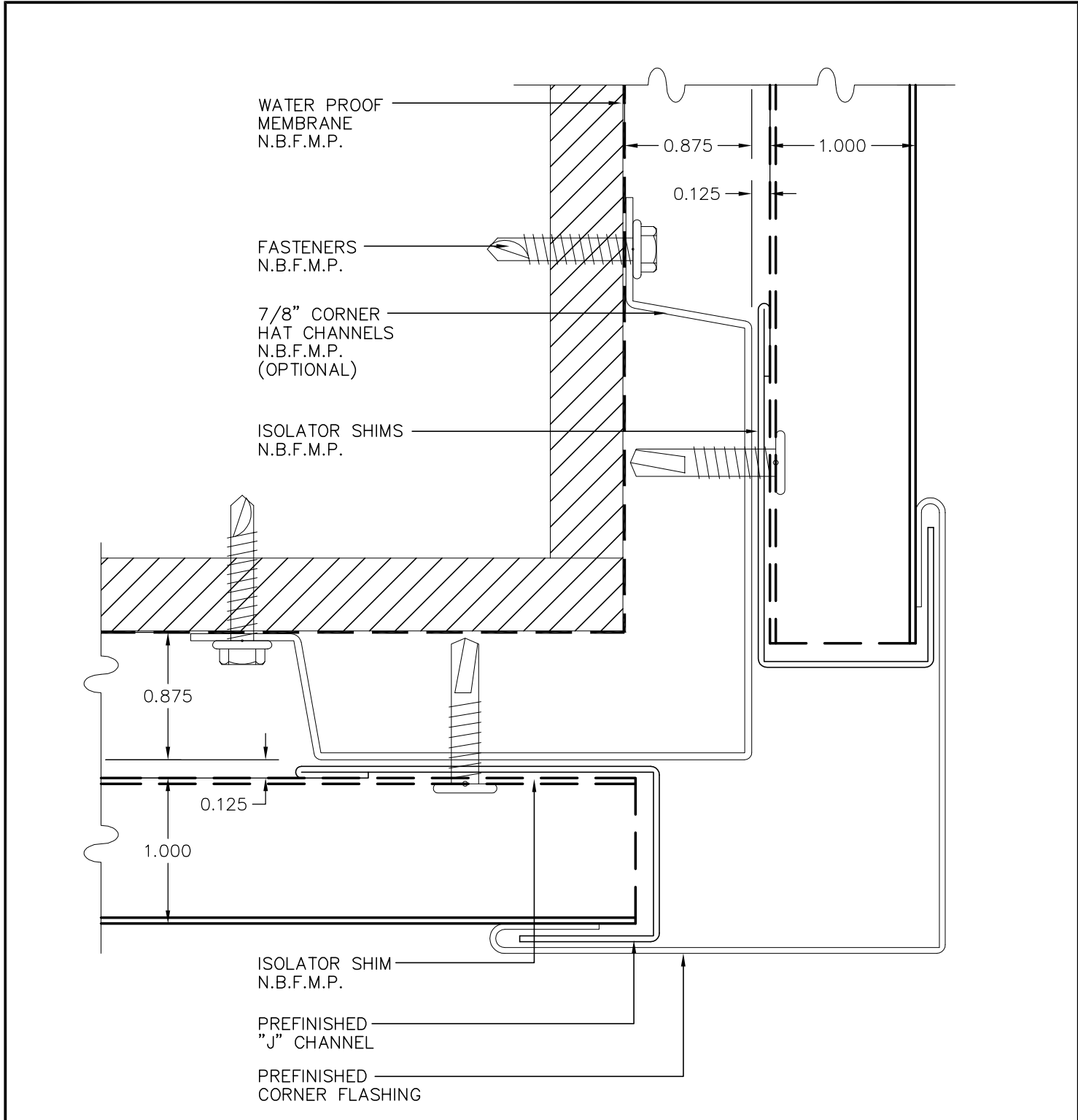

UC501 - SOFFIT DETAIL

UC501-06

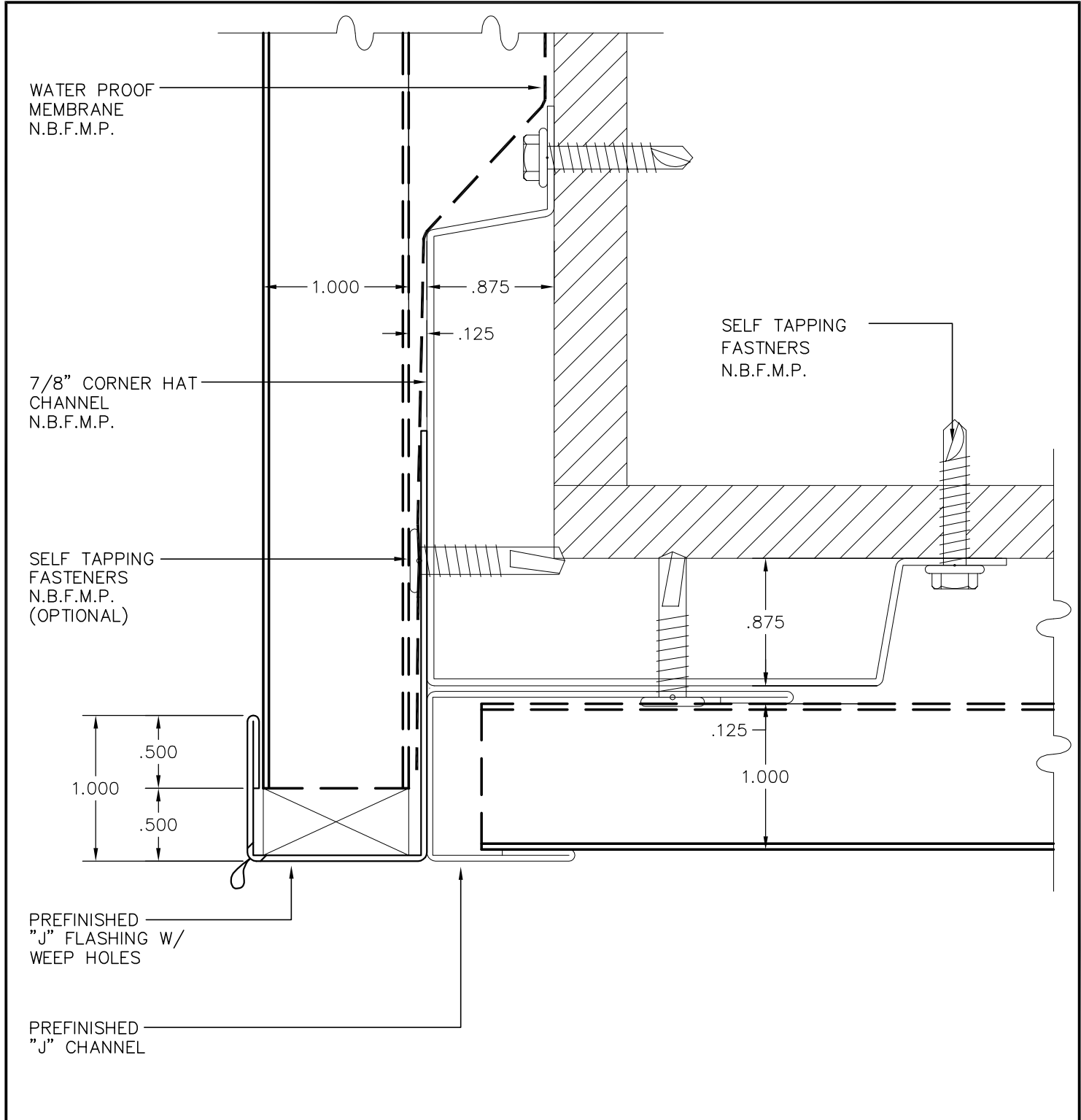

UC501 - WINDOW HEAD/JAMB DETAIL

UC501-07

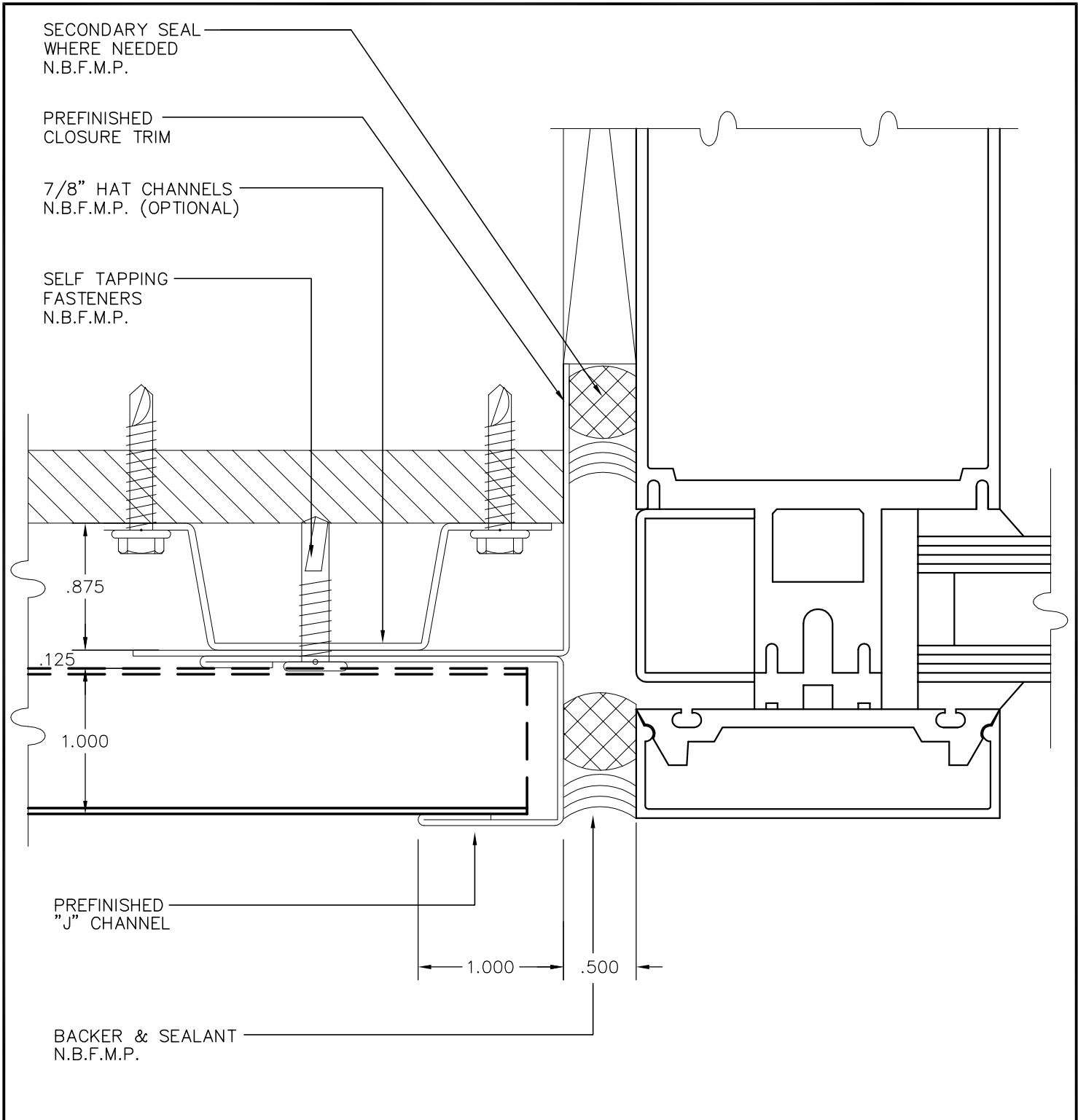

UC501 - WINDOW HEAD DETAIL @ SOFFIT

UC501-08

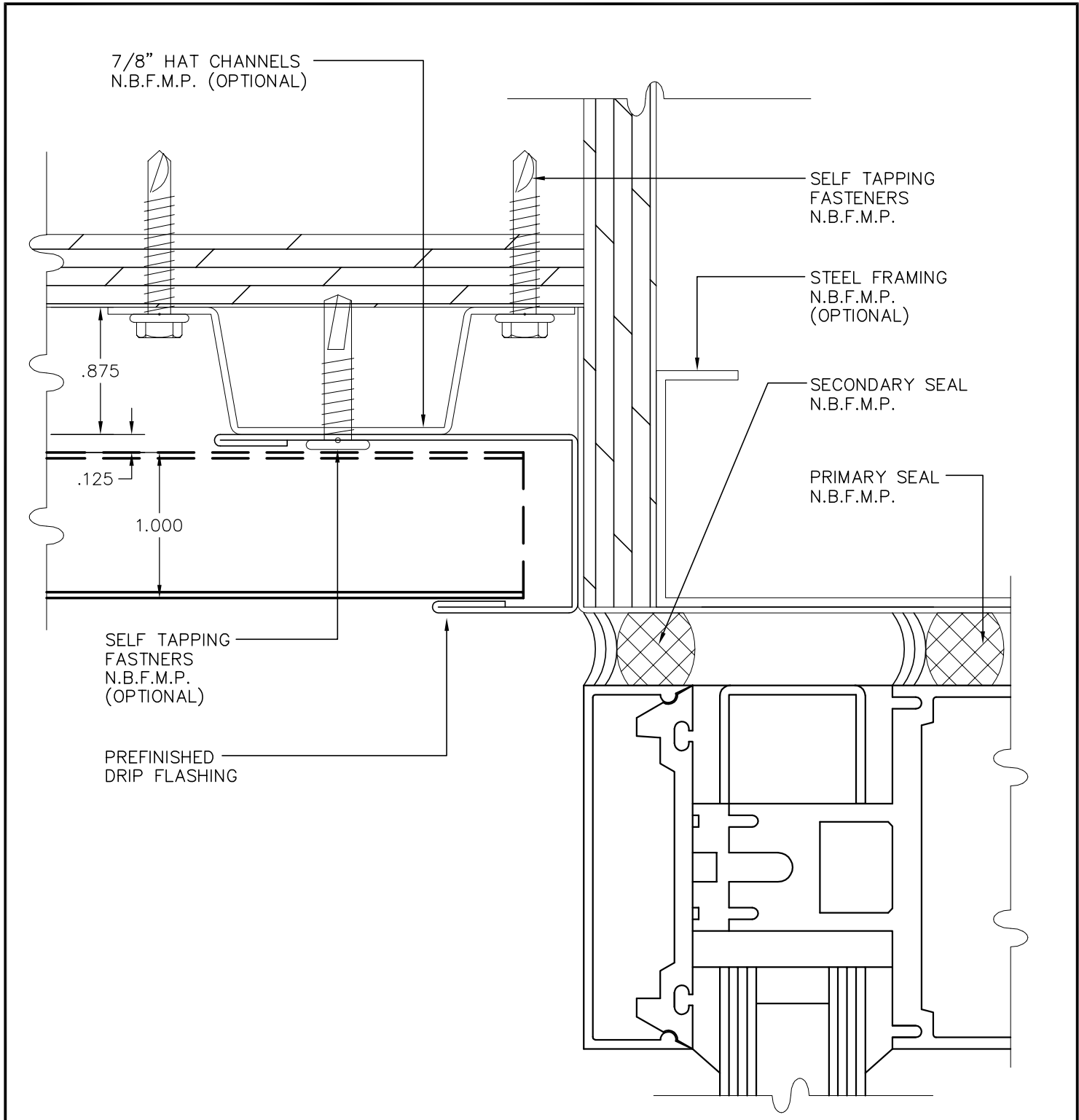

UC501 - WINDOW SILL DETAIL

UC501-09

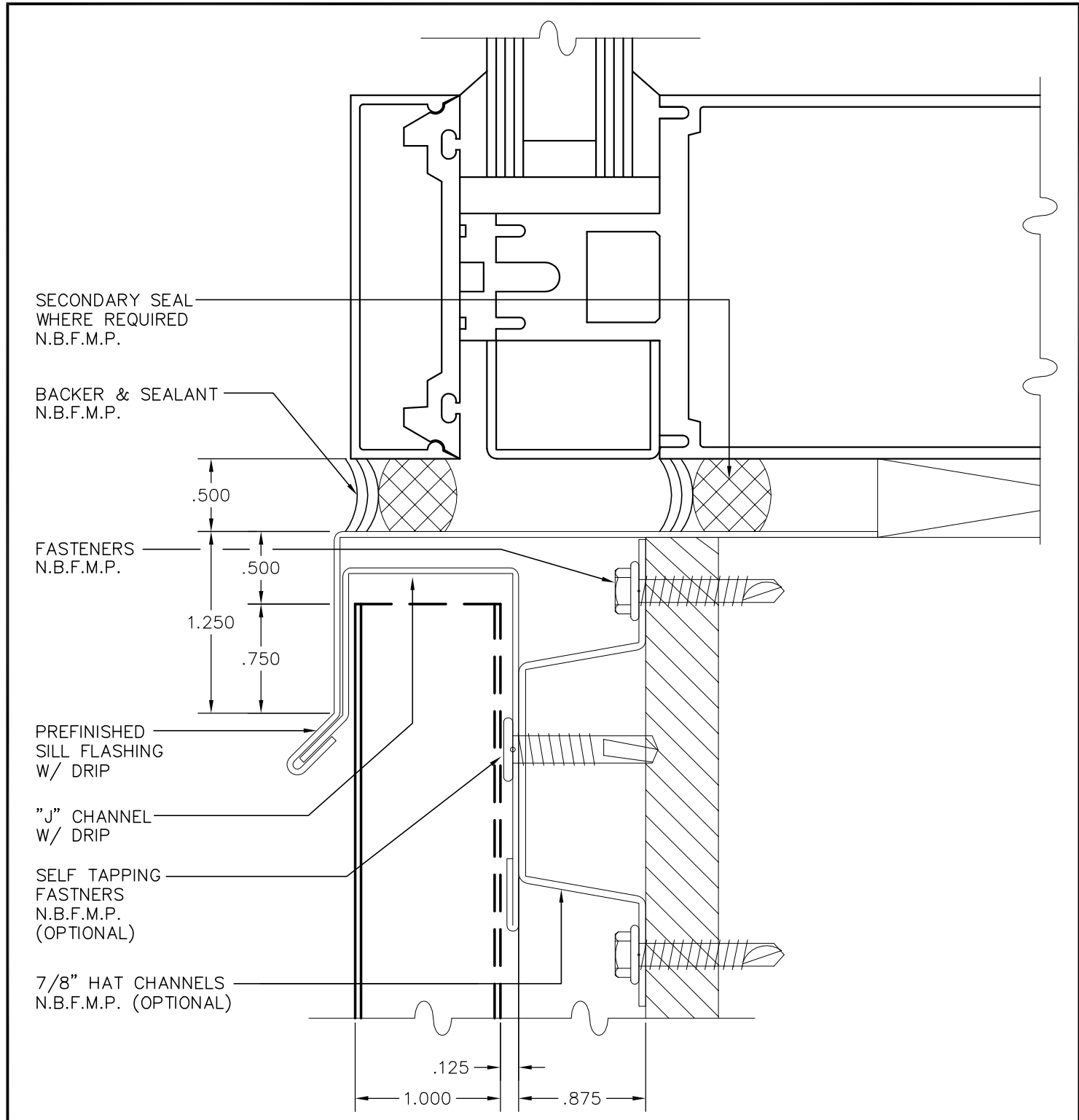

UC501 - BASE DETAIL

UC501-10

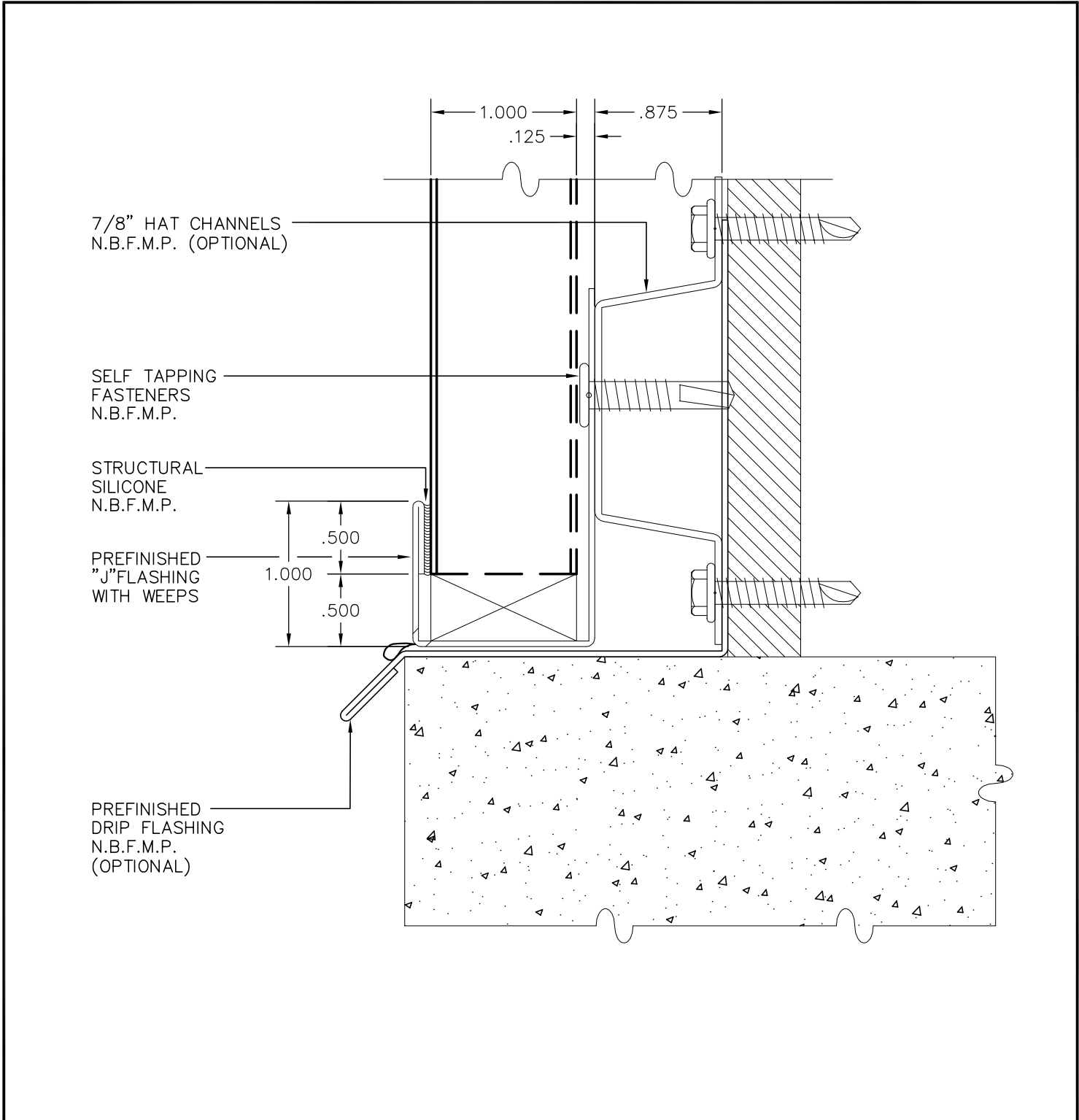

UC501 - INSIDE CORNER DETAIL

UC501-11

